

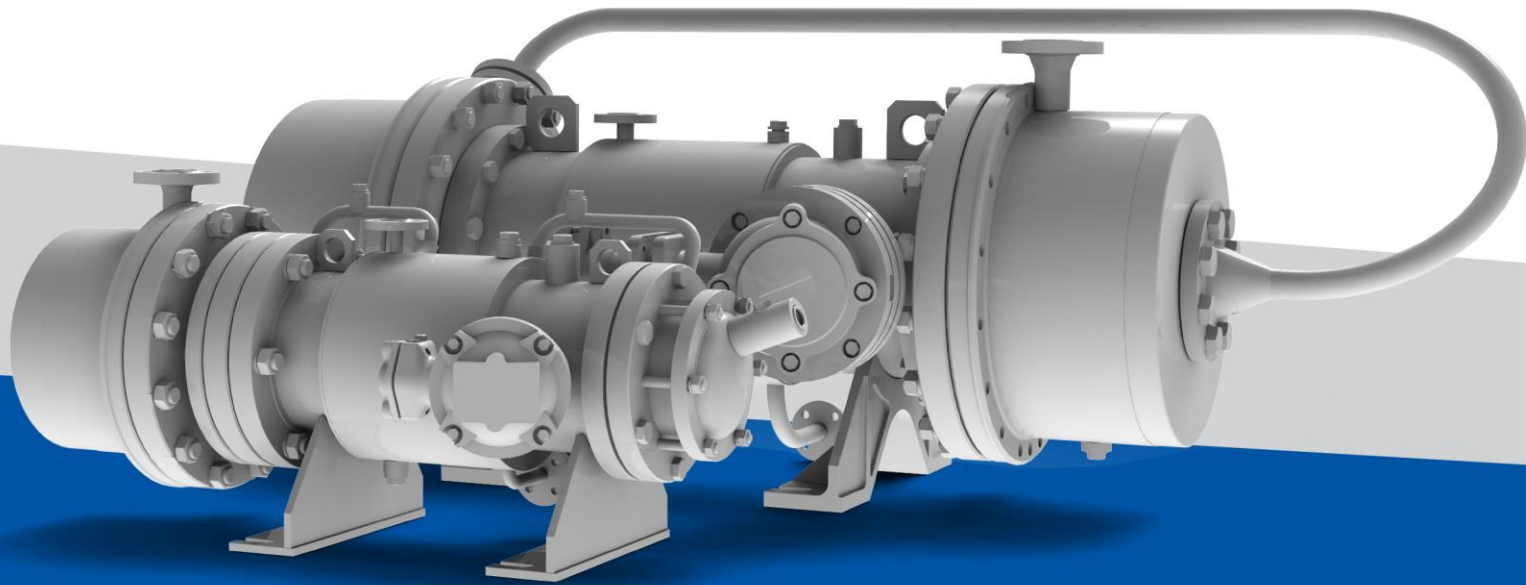

COMPANY PRESENTATION, PRODUCT OVERVIEW

CANNED MOTOR PUMPS



CONTENT

Chapter I	Historical background of CRIS Hermetic Pumps
Chapter II	Goals and mission of CRIS Hermetic Pumps
Chapter III	Clients of CRIS Hermetic Pumps
Chapter IV	Why sealed electric pumps?
Chapter V	Products of CRIS Hermetic Pumps
Chapter VI	Electric pumps of CH series
Chapter VII	Electric pumps of NH series
Chapter VIII	Electric pumps of CMP series
Chapter IX	Transformer electric pumps
Chapter X	Manufacturing of CRIS Hermetic Pumps

CHAPTER I HISTORICAL BACKGROUND of CRIS HERMETIC PUMPS

Historical background of CRIS Hermetic Pumps



The company **CRIS Hermetic Pumps** specializes in the design and manufacture of reliable and economical centrifugal explosion-proof sealed electric pumps, the family of which is produced and refined in the Republic of Moldova since 1961.

Starting with 1961, plants for the production of explosion-proof sealed centrifugal pumps of the Republic of Moldova have been providing the entire Soviet Union with electric pump units for use in the chemical, oil and gas, nuclear, metallurgical, pharmaceutical industry, defense industry enterprise, as well as in the energy and transport fields. Thus, our specialists have continuity and a very good experience and understanding of the scope of application, development and production of this pumping equipment class.



Historical background of CRIS Hermetic Pumps



- In 1994, the sealed pumps plant CRIS Hermetic Pumps was founded as a company, specializing in the supply, commissioning and maintenance of industrial and pumping equipment.
- Since 1998, one of the main activities of CRIS Hermetic Pumps was the introduction in technological processes and the implementation in the petrochemical complex enterprises of the CIS countries, Baltic and Eastern European countries of sealed explosion-proof electric pumps of CH, NH and CMP series, produced by "Moldovahidromash" as an official enterprise dealer.
- Starting with 2005-2006, a comprehensive development work of own production was performed, and since 2007, CRIS Hermetic Pumps is certified as a manufacturer of explosion-proof sealed centrifugal pumps of CH, NH and CMP series, as well as the sealed transformer electric pumps of MT, TT and TE type.

Historical background of CRIS Hermetic Pumps



- **2009-2011**. Regular customers of the company become the flagships of the petrochemical industry JSC "LUKOIL", OJSC "SIBUR" (Russia), JSC "NAFTAN", OJSC "NIZHNEKAMSKNEFTEKHIM", OJSC "MOGILEVKHIMVOLOKNO" (RB), "KAZANSKII" refinery and other large enterprises of CIS countries.
- **In 2013**, a decision is made on the establishment of foundry production. At the end of **2014**, commissioning works are completed, and the first batch of parts is molded for hermetically sealed electric pumps.
- **In 2015**, the implementation process takes place, as well as the quality management system certification in accordance with **ISO 9001** international standard and certification of products manufactured in accordance with **API 685** standards.
- Currently, CRIS Hermetic Pumps is a dynamic engineering company, numbering about 100 personnel, equipped with advanced technology and equipment, certified under GOST R standards of TR TC 010/2011 and 012/2011.



CHAPTER II
GOALS AND MISSION
CRIS HERMETIC PUMPS

Goals and mission CRIS Hermetic Pumps



Our goal is to become the leading company in the production of explosion-proof sealed centrifugal electric pumps.

Our mission, as a leading company, we see in the provision of goods and services of the highest quality at the best price.

Our values are to act for the benefit of everyone close to us, including our customers' benefit.



CHAPTER III
CLIENTS
CRIS HERMETIC PUMPS

Some clients of CRIS Hermetic Pumps



CHAPTER IV

WHY SEALED ELECTRIC PUMPS?

Why sealed electric pumps?

ENVIRONMENT PROTECTION AND SAFETY

- absolute tightness of the electric pump;
- safety of personnel, equipment and environment;
- low noise and vibration levels.

LOW OPERATING COSTS

- one-piece structure of the electric pump;
- low maintenance costs;
- easy installation;
- increased reliability;
- lack of wear parts;
- durable radial and plain thrust bearings.

INCREASED RELIABILITY

- simple structure;
- explosion-proof design;
- corrosion-resistant materials .

CHAPTER V

PRODUCTS of CRIS HERMETIC PUMPS

Electric pumps by CRIS Hermetic Pumps are produced in accordance with the requirements of international standards and norms, including the API 685 standard, and provide pumping in steady-state conditions of reactive, corrosive, toxic, flammable and containing harmful substances liquids of all classes of danger (including liquefied gases and neutral liquids), pairs of which combined with air may form explosive mixtures .

TYPES OF ELECTRIC PUMPS

- Electric pumps of **CH** series represent a parametric range in accordance with GOST 20791 and are designed for pumping in steady-state conditions of more than 500 types of reactive, corrosive, toxic, flammable and other liquids, vapors of which in combination with air may form explosive mixtures, with a mass fraction of solid nonabrasive impurities of up to 0,2%, and particle size of up to 0.2 mm.
- Electric pumps of **NH** series are designed on the basis of the parameters range of the same standard and are designed for pumping liquefied hydrocarbons, petroleum fuels and other similar non-corrosive liquids;
- Special pumps of **CMP** series are developed for specific parameters and operating conditions, specified by the Customer, and are designed for pumping in stationary conditions of reactive, corrosive, toxic, flammable and containing hazardous substances liquids of all hazard classes, vapors of which in combination with air may form explosive mixtures.
- Transformer electric pumps **MT**, **TT** and **TE** are designed for providing circulation in transformer cooling systems, both stationary (**MT**, **TE**) and for rolling stock (**TT**).

STRUCTURAL FEATURES OF ELECTRIC PUMPS BY CRIS

- One-piece structure design that combines the pump body and the integrated hermetic induction motor in a single mono-block;
- No external seal of rotating parts;
- Cooling of the inner chamber of the motor, secured with thin-walled non-magnetic sleeves and lubrication of plain bearings is made by the pumped liquid;
- The one-sided entrance impeller is of closed type with a groove seal, which eliminates the possibility for random particles of falling into the motor chamber;
- The construction of sealed one-piece electric pumps provides automatic unloading from axial forces arising during operation, thus providing an optimum location of rotor with the impellers fixed on it.

Products of CRIS Hermetic Pumps



MAIN COMPONENTS OF HERMETIC ELECTRIC PUMPS

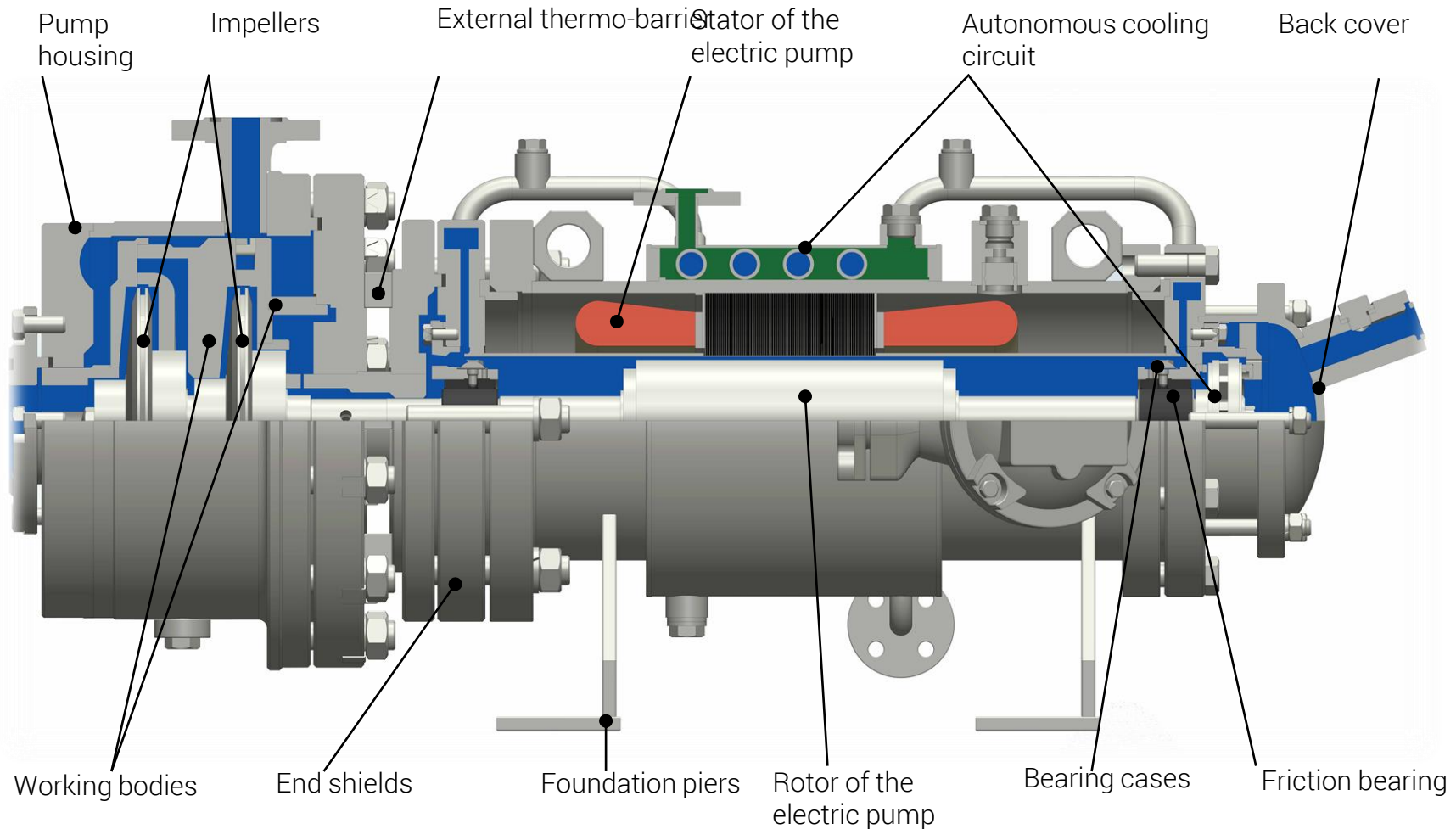

CHAPTER VI CANNED MOTOR PUMPS OF CH SERIES

Canned motor pumps of ch series, are designed for pumping in steady-state condition of more than 500 types of chemically active, corrosive, toxic, flammable and other liquids, vapors of which may form explosive mixtures with air..

Canned motor pumps of CH series

CANNED MOTOR PUMPS OF CH SERIES, TYPES 1,4

- Single-stage pumps;
- Pumping of corrosive liquids with a corrosion rate of 0.01 mm per year for the steel of flow section 12X18H10T, 10X17H13M2T;
- Explosion protection in accordance with 1ExdsIIBT 4X, 1ExdsIICT 4 X.

Productive capacity:	3,2 - 100 m ³ /h;
Pumping head:	12.5 - 125 m;
Rotary speed:	1500 - 3000 min ⁻¹ ;
Working temperature:	max. +50 °C;
Viscosity:	up to 50 mm ² /s;
Pressure in the circuit:	up to 50 bar;
Engine power:	1,1 - 37 kWt.



Canned motor pumps of CH series

CANNED MOTOR PUMPS OF CH SERIES, TYPES 1,4

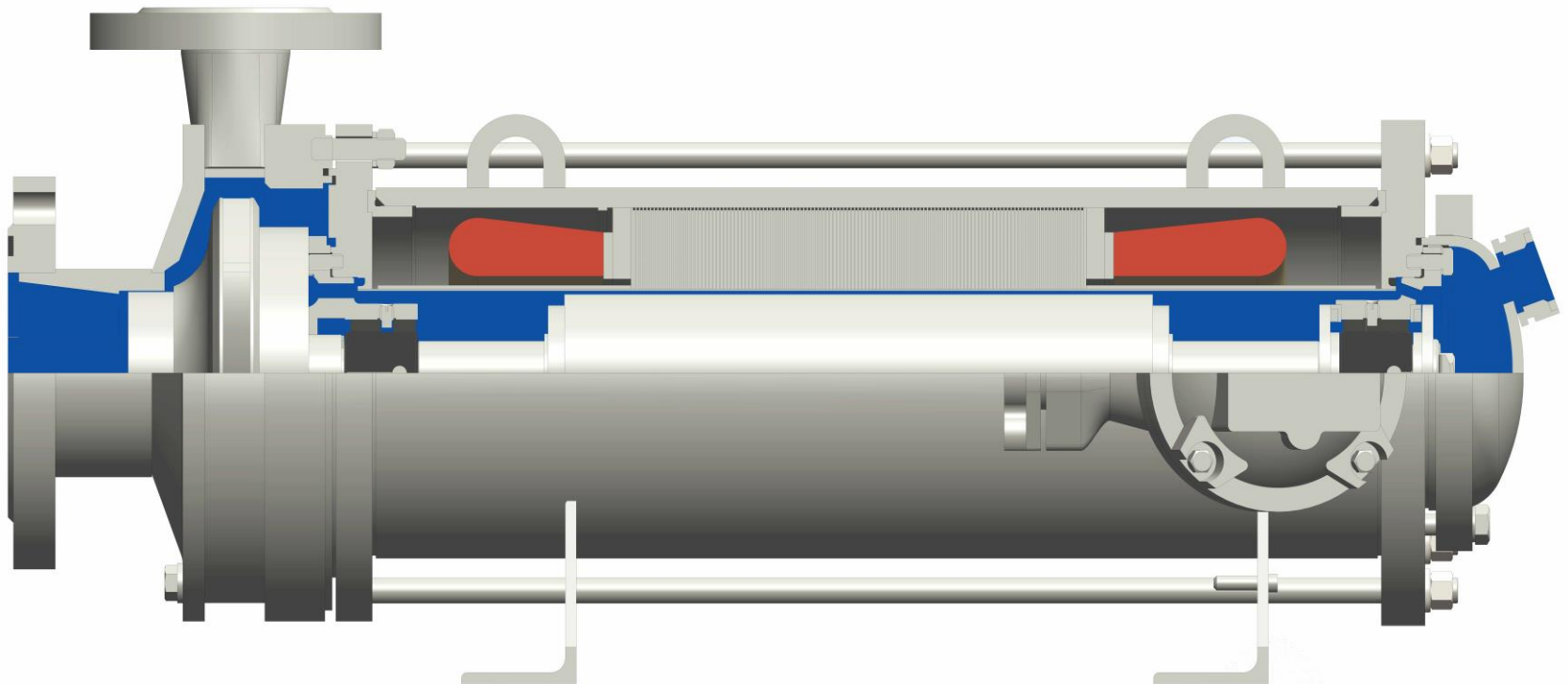

Canned motor pumps of CH series

Canned motor pumps of CH series, types 2, 5

- Sealed one-piece single-stage;
- Pumping of corrosive liquids with a corrosion rate of up to 0,01 mm per year for the steel of flow section 12X18H10T, 10X17H13M2T;
- Explosion protection in accordance with 1ExdsIIBT 4X, 1ExdsIICT 4 X.

Productive capacity:	3,2 - 200 m ³ /h;
Pumping head:	12.5 - 200 m;
Rotary speed:	1500 - 3000 min ⁻¹ ;
Working temperature:	max. +100 °C;
Viscosity:	up to 50 mm ² /s;
Pressure in the circuit:	up to 50 bar;
Engine power:	1,1 - 132 kWt.



Canned motor pumps of CH series

Canned motor pumps of CH series, types 2, 5

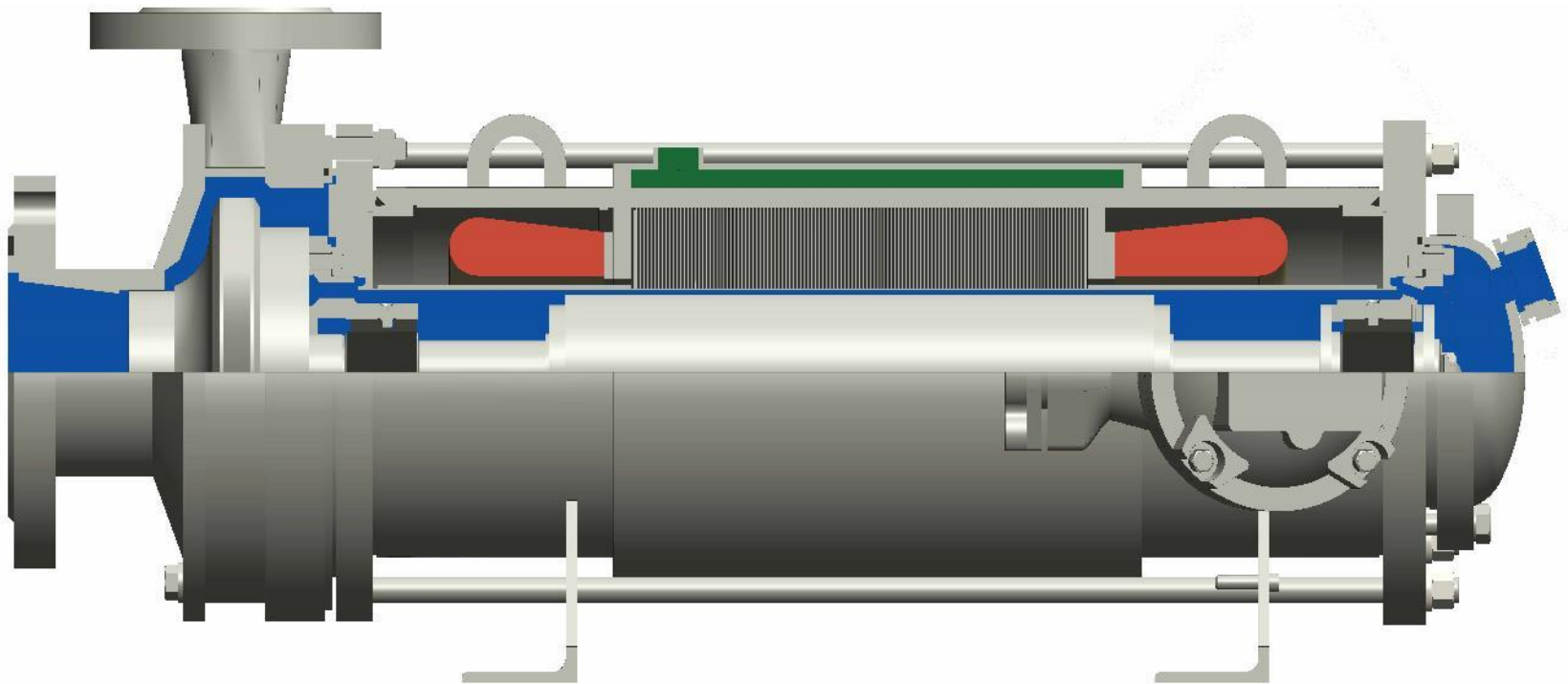

Canned motor pumps of CH series

Canned motor pumps of CH series, types 3, 6

- Sealed one-piece single-stage;
- Pumping of corrosive liquids with a corrosion rate of up to 0.01 mm per year for the steel of flow section 12X18H10T, 10X17H13M2T;
- Explosion protection in accordance with 1ExdsIIBT (1-4)X, 1ExdsIICT (1-4) X.

Productive capacity:	3,2 - 200 m ³ /h;
Pumping head:	12.5 - 125 m;
Rotary speed:	1500 - 3000 min ⁻¹ ;
Working temperature:	max. +360°C;
Viscosity:	up to 50 mm ² /s;
Pressure in the circuit:	up to 50 bar;
Engine power:	1,1 - 75 kWt.

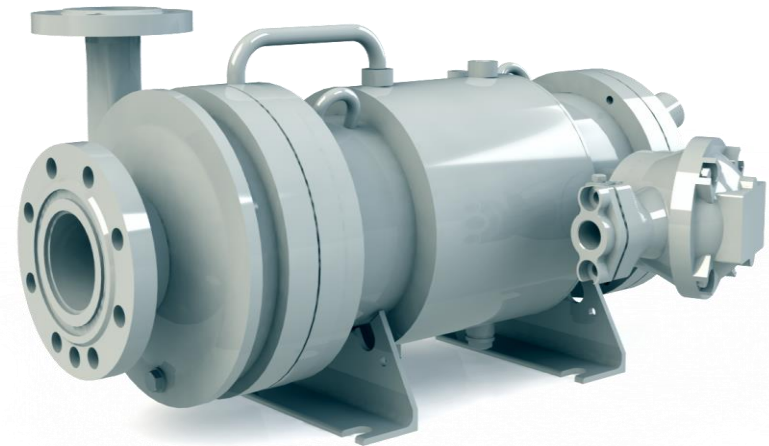

Canned motor pumps of CH series

Canned motor pumps of CH series, types 3, 6

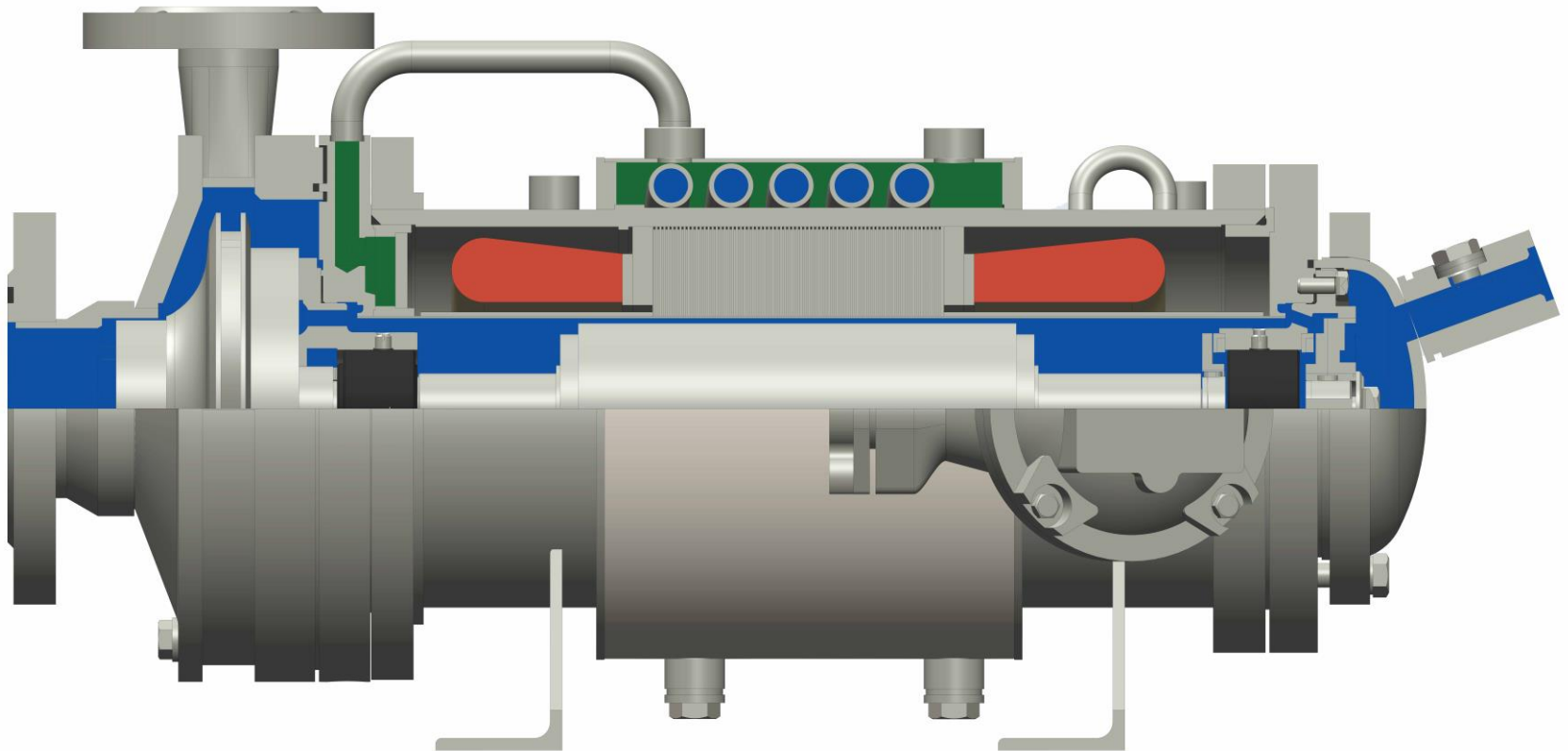

CHAPTER VII

ELECTRIC PUMPS OF NH SERIES

Electric pumps of NG type are designed for pumping liquefied hydrocarbons, petroleum fuels and other similar non-corrosive liquids;

Canned motor pumps of NH series

Canned motor pumps of NH series, types 1, 2, 4, 5

- Sealed one-piece single-stage;
- Pumping of non-aggressive liquids with a corrosion rate of up to 0.01 mm per year for the carbon steel flow section;
- Explosion protection in accordance with 1ExdsIIBT 4X.

Productive capacity:	3,2 - 500 m ³ /h;
Pumping head:	20 - 125 m;
Rotary speed:	1500 - 3000 min ⁻¹ ;
Working temperature:	from -40 to +100 °C;
Viscosity:	up to 40 mm ² /s;
Pressure in the circuit:	up to 40 bar;
Engine power:	1,5 - 132 kWt.

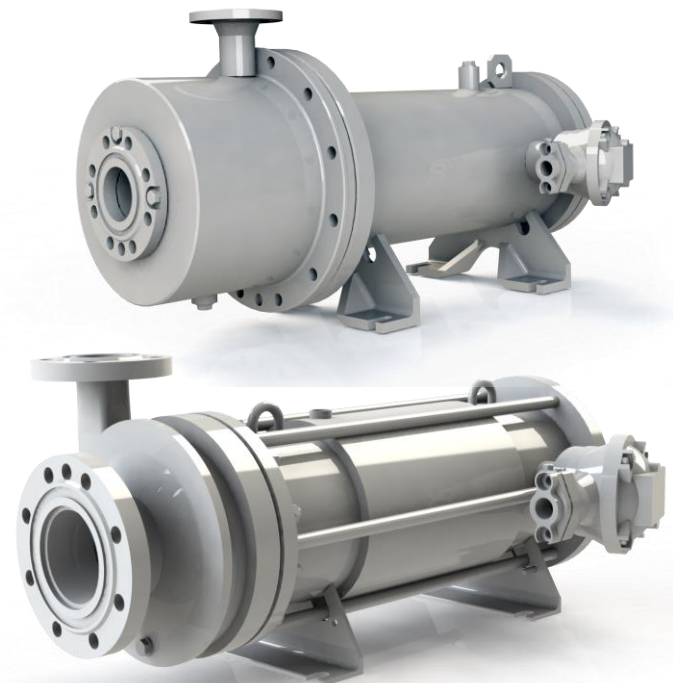

Canned motor pumps of NH series

Canned motor pumps of NH series, types 1, 2, 4, 5

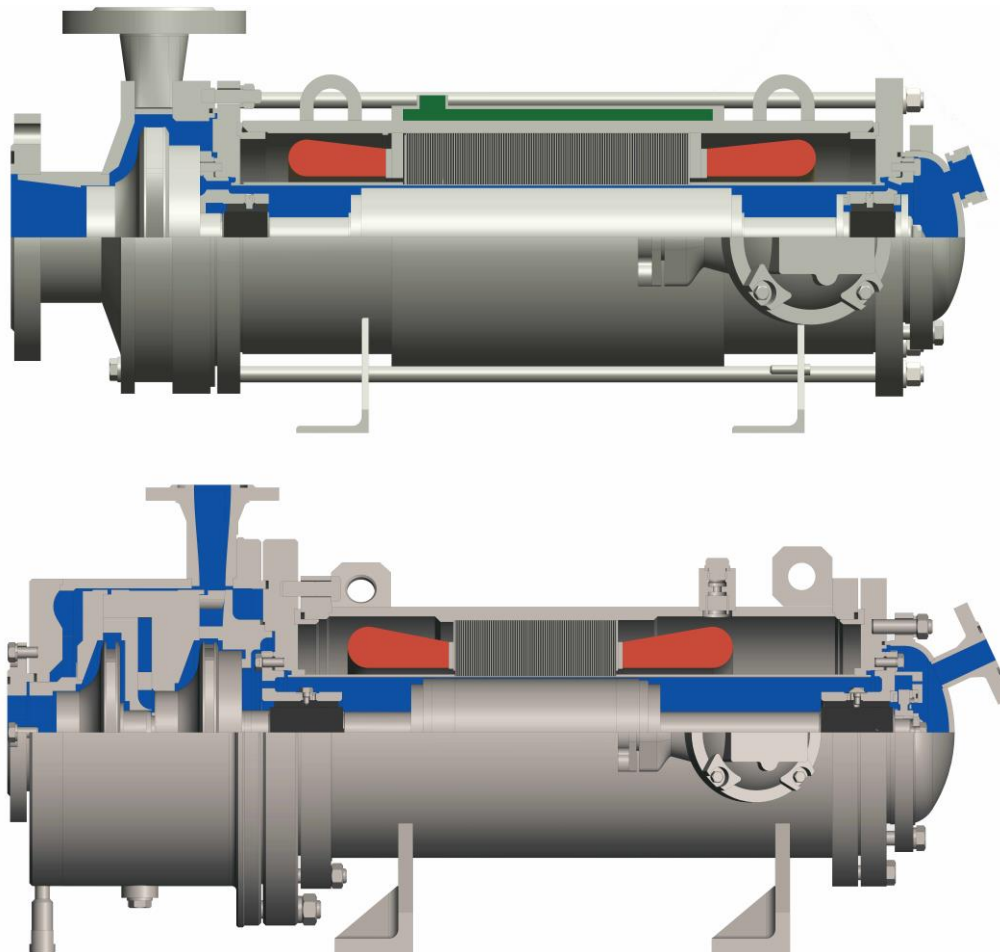

CHAPTER VIII

ELECTRIC PUMPS OF CMP SERIES

Electric pumps of CMP series are developed under the specific operating conditions and are designed for pumping in stationary conditions of chemically active, corrosive, toxic, flammable and other liquids, vapors of which may form explosive mixtures with air.

Canned motor pumps of CMP series

Canned motor pumps of CMP O series

- Single-stage pumps;
- Pumping of aggressive liquids with a corrosion rate of up to 0.01 mm per year for the steel flow section 12X18H10T, 10X17H13M2T;
- Explosion protection in accordance with 1ExdsIIBT (1-4)X, 1ExdsIICT (1-4) X.

Productive capacity:	0,5 - 500 m ³ /h;
Pumping head:	20 - 200 m;
Rotary speed:	1500 - 3000 min ⁻¹ ;
Working temperature:	-100°C to +450 °C;
Viscosity:	up to 50 mm ² /s;
Pressure in the circuit:	up to 100 bar;
Engine power:	1,1 - 200 kWt.

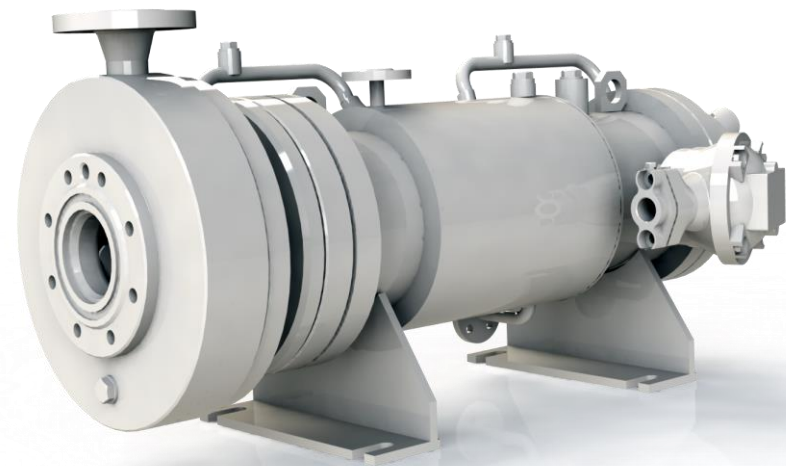

Canned motor pumps of CMP series

CRIS
HERMETIC PUMPS

Canned motor pumps of CMP 0 series

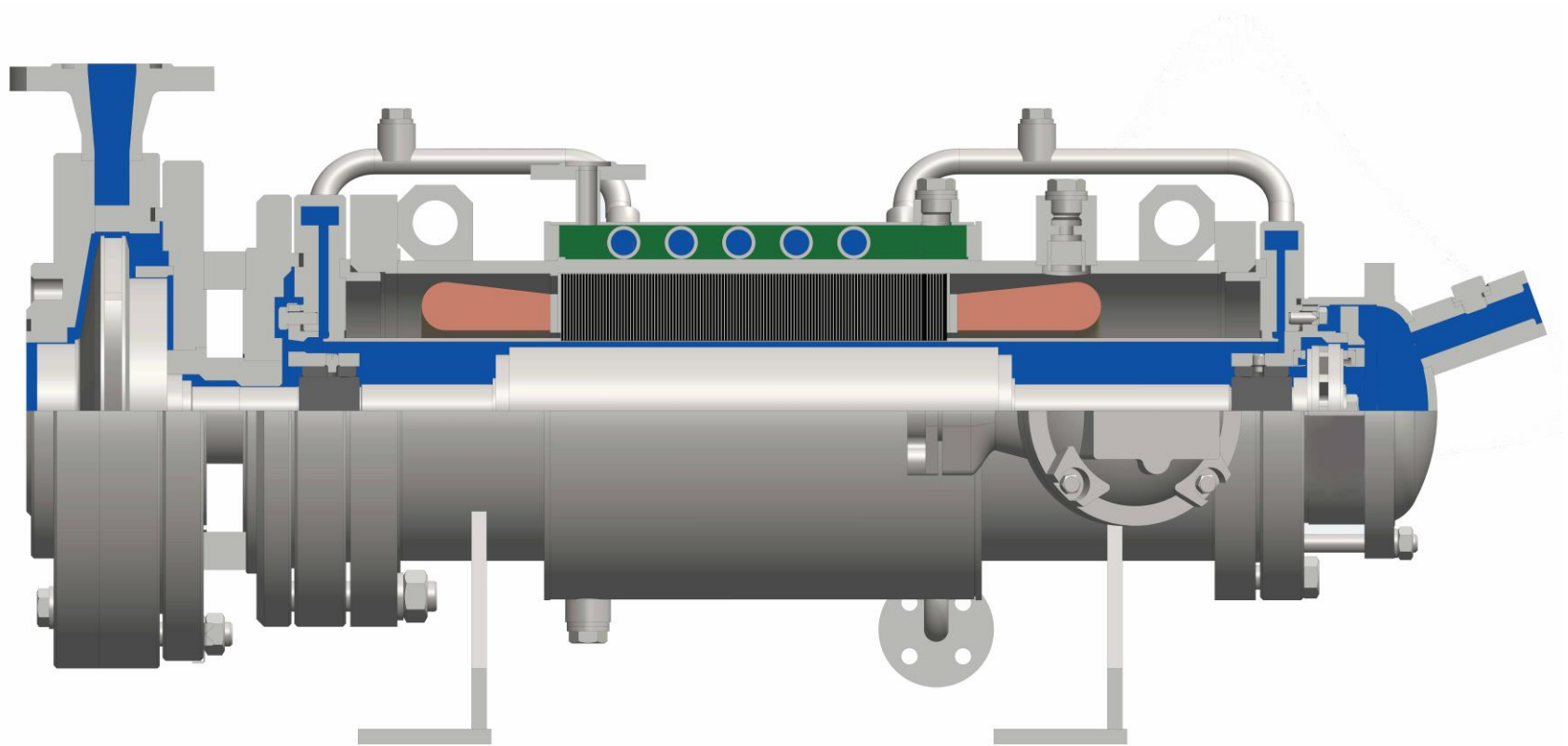

Canned motor pumps of CMP series

Canned motor pumps of CMP M series

- Multistage pumps;
- Pumping of aggressive liquids with a corrosion rate of up to 0.01 mm per year for the steel flow section 12X18H10T, 10X17H13M2T;
- Explosion protection in accordance with 1ExdsIIBT (1-4)X, 1ExdsIICT (1-4) X.

Productive capacity:	0,5 - 500 m ³ /h;
Pumping head:	40 - 400 m;
Rotary speed:	1500 - 3000 min ⁻¹ ;
Working temperature:	-100°C to +450 °C;
Viscosity:	up to 50 mm ² /s;
Pressure in the circuit:	up to 100 bar;
Engine power:	1,1 - 250 kWt.

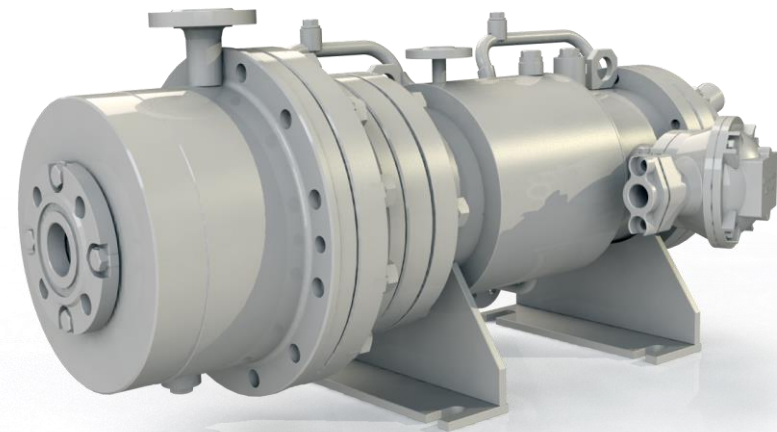

Canned motor pumps of CMP series

CRIS
HERMETIC PUMPS

Canned motor pumps of CMP M series

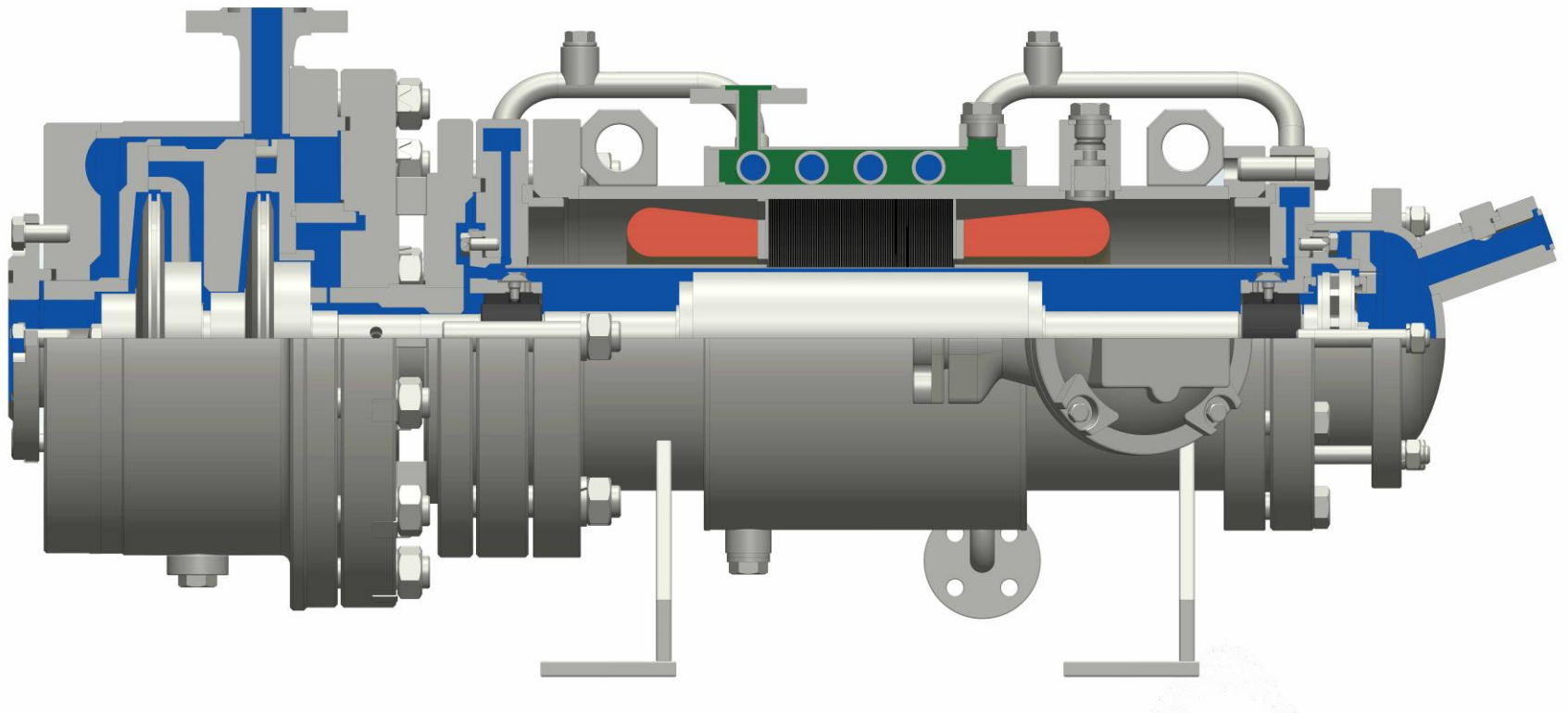

Canned motor pumps of CMP series

Canned motor pumps of CMP BM series

- Multistage pumps
- Pumping of aggressive liquids with a corrosion rate of up to 0.01 mm per year for the steel flow section 12X18H10T, 10X17H13M2T;
- Explosion protection in accordance 1ExdsIIBT (1-4)X, 1ExdsIICT (1-4) X.

Productive capacity:	0,5 - 250 m ³ /h;
Pumping head:	80 - 1000 m;
Rotary speed:	1500 -- 3000 min ⁻¹ ;
Working temperature:	max. +100 °C;
Viscosity:	up to 50 mm ² /s;
Pressure in the circuit:	up to 100 bar;
Engine power:	5 - 250 kWt.

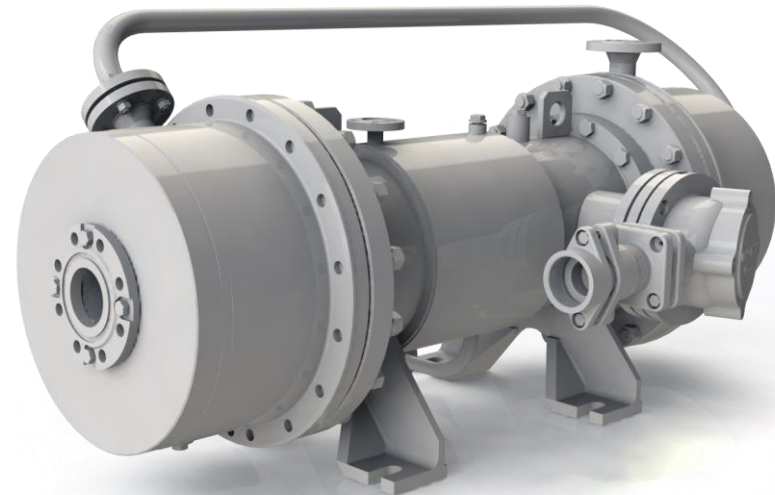

Canned motor pumps of CMP series

CRIS
HERMETIC PUMPS

Canned motor pumps of CMP BM series

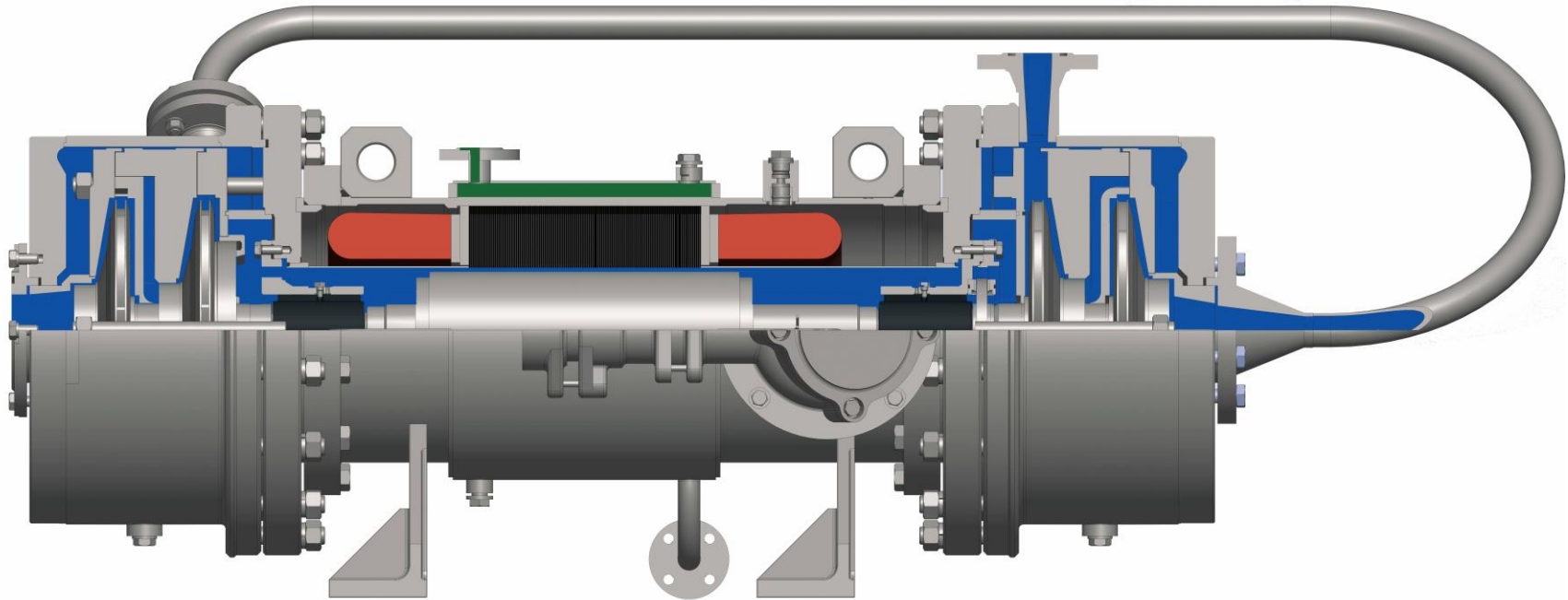

Transformer electric pumps

Transformer electric pumps

Designed for creating a circulation of transformer oil in the cooling systems of power transformers of mainline electric locomotives (TT) and stationary power transformers of power plants (TE, MT). Features: one-piece pumps, with oil-flooded stators (TT and MT) and sleeved stator (TE).

Reference code of the electric pump	Supply, m ³ /h	Head, m	Engine power, kWt	Cavitation margin, m	Pressure in the system, not more. kgf/cm ²	Liquid density, kg/m ³	Liquid temperature, °C
TT 63-10	63	10	2,2	3,5	4	840	85
MT 16-10	16	10	1,1	4,0	4	840	85
2TЭ 100-8	100	8	3,5	5,0	4	840	80
1TЭ 100-15	100	15	7,5	5,0	4	840	80
1TЭ 100-20	100	20	7,5	5,0	4	840	80
6TЭ 160-10	160	10	5,5	5,0	4	840	80

CHAPTER IX
DEVELOPMENT AND PRODUCTION
OF PUMPS BY
CRIS HERMETIC PUMPS

Development and production of pumps by CRIS Hermetic Pumps



Design and Technology department

The most important division of the company, the goal of which is the development of sealed electric pump units, as well as the normative and technical documentation.

Individual approach of the department specialists to each project and the use of modern CAD, CAM, CAE solutions in the design allows obtaining a high-quality pumping equipment that best matches the needs of the Customer.



Development and production of pumps by CRIS Hermetic Pumps



Blank section

Provision of core production with the entire range of blanks and semi-finished products using the most modern equipment, including the plasma metal cutting unit.

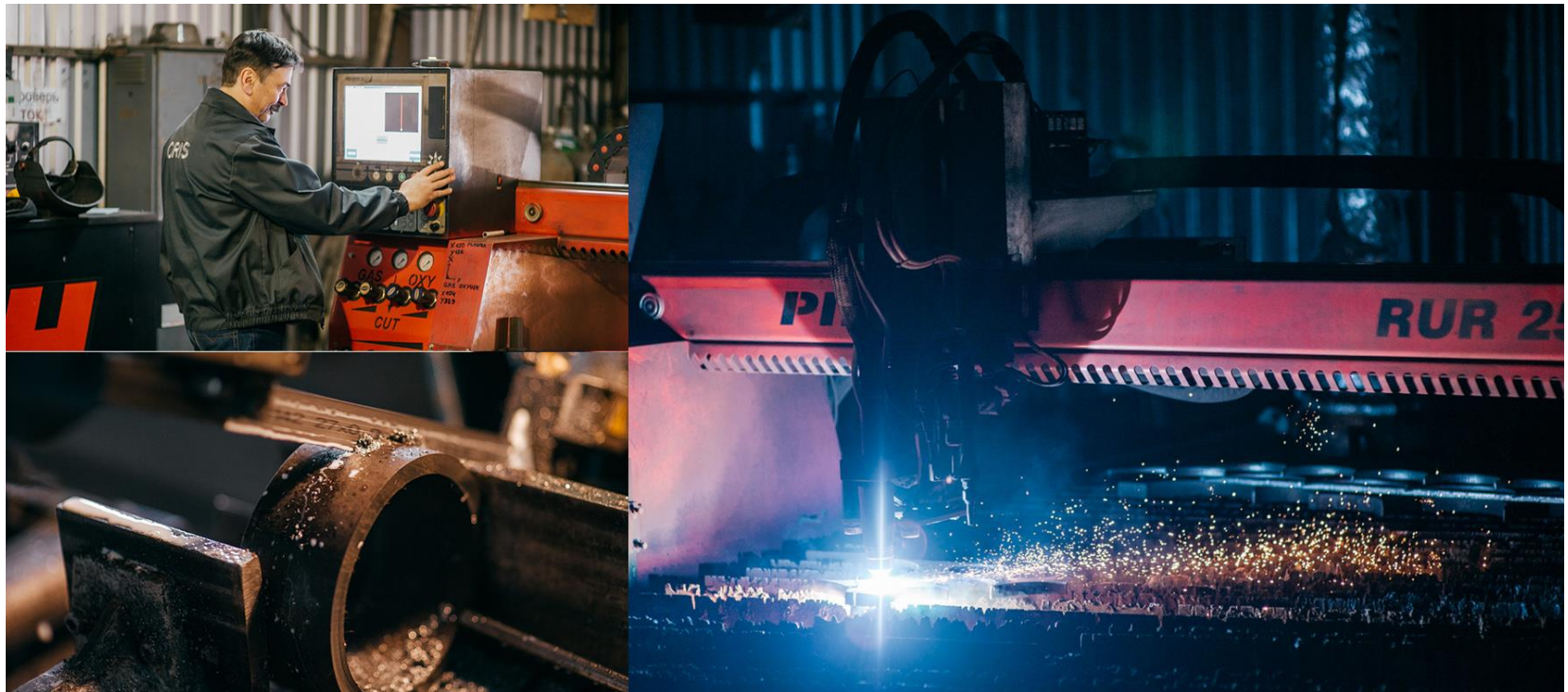

Development and production of pumps by CRIS Hermetic Pumps



Foundry production

Using modern inductor furnaces, hot investment casting techniques and casting in HTS provides the core production with cast components of pumping equipment - impellers, bearing housings, pump housings, terminal boxes, etc. At that, it provides a high casting quality and strict adherence to the required chemical composition of the cast parts.



Development and production of pumps by CRIS Hermetic Pumps



Mechanical manufacturing

Main manufacturing process of the enterprise, performing the mechanical processing of parts and assembly units of the pump equipment. Using numerically controlled machines, advanced materials processing methods and high production culture allow providing a high quality level of manufactured products and, respectively, of the final pump equipment.

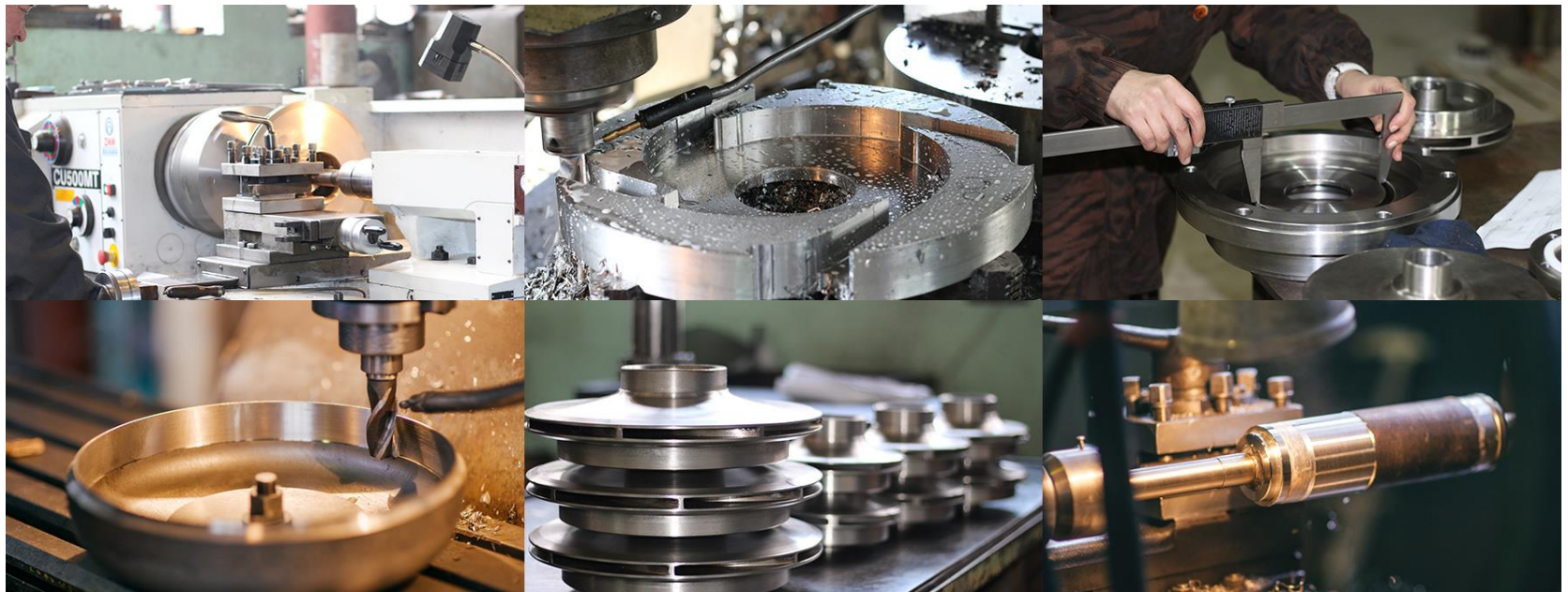

Development and production of pumps by CRIS Hermetic Pumps



Winding production

Production of hermetic stators for electric motors with a capacity of 1.1 to 250 kW. Modern technologies and materials, vacuum impregnation method, and high drying techniques determine the high quality level of the finished product.



Development and production of pumps by CRIS Hermetic Pumps



Assembly department and electric pumps testing

An extremely responsible phase in the manufacture of products is the process of assembly and testing of electric pumps - tasks performed on the production assembly and testing station. Full inspection of parts and components in the products assembly process, strict implementation of assembly technology, as well as 100% testing of finished products allow the Company to guarantee high quality of manufactured products.

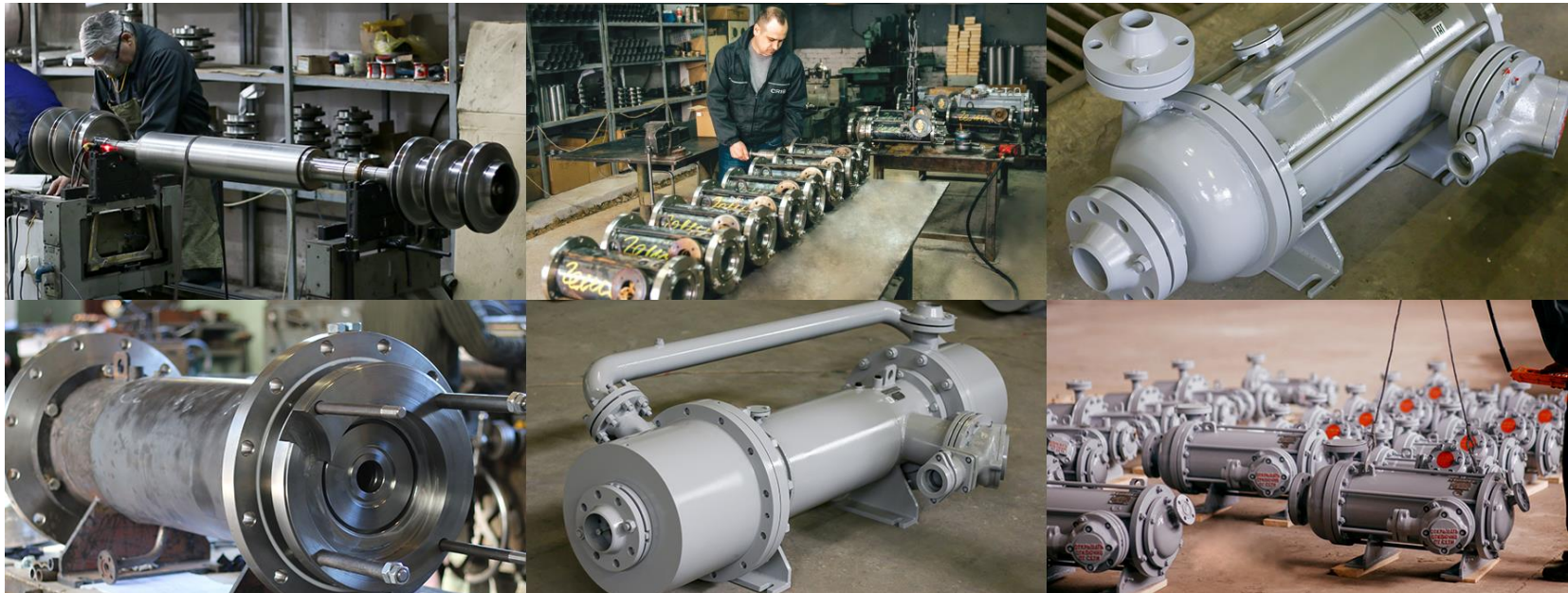



THANK YOU FOR ATTENTION

P: +373 22 479 247 E: info@crispumps.com W: www.crispumps.com
A: 68/2-69 Albișoara St., Chișinău MD-2005, Republic of Moldova